



Carter Collection

LH2. COR, RH2 corner group shown in Polly Cotton (Cover 1), Asra Earth (Cover 2) and Duke Bottle Green (Cover 3).

Colours represented are to be used as a guide only, colour shadings can vary slightly from each roll of fabric/leather hide. Please refer to manufacturers swatch for more colour options.

foamflex⁺

CARTER COVER GUIDE - STANDARD BACK

Please use this guide when ordering the following pieces to clarify cover options.

STANDARD BACK

LH2, FST, COR, ALU, RH1 Group

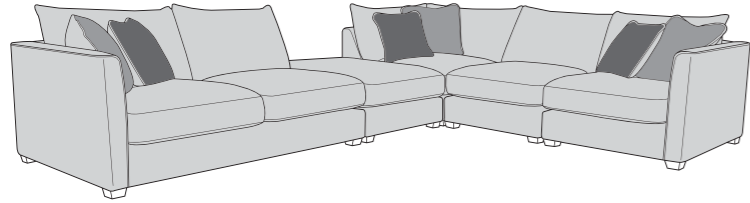

LH1, ALU, COR, FST, RH2 Group

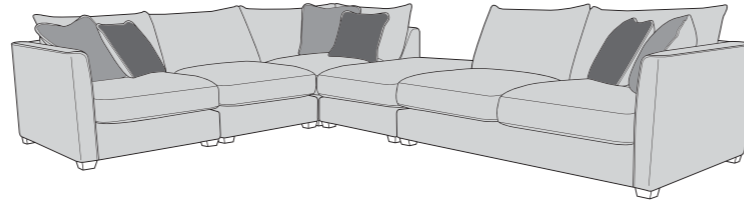

LH2, COR, ALU, RH1 Group

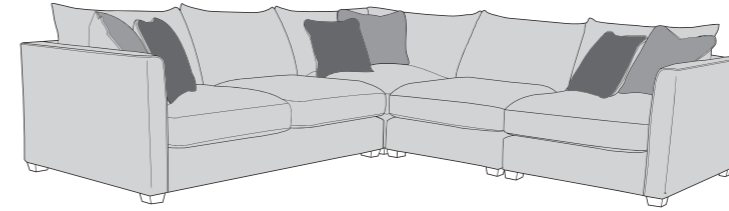

LH1, ALU, COR, RH2 Group

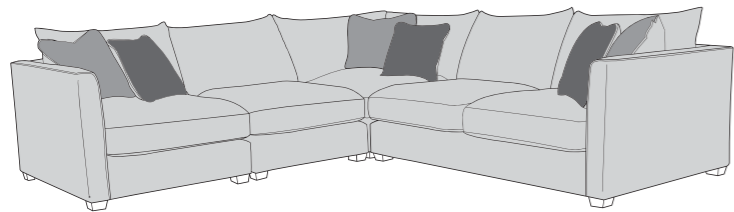

LH2, COR, ALU, FST Group

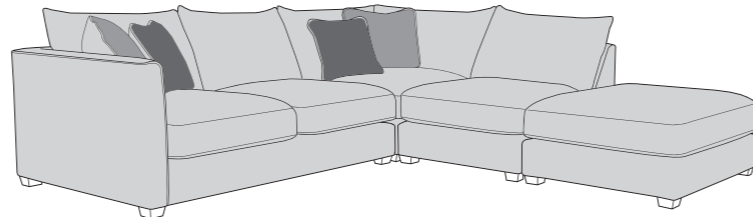

FST, ALU, COR, RH2 Group

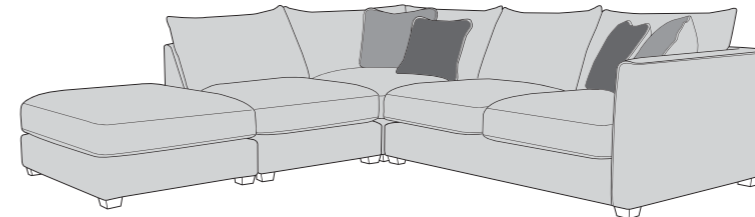

LH2, COR, RH2 Group

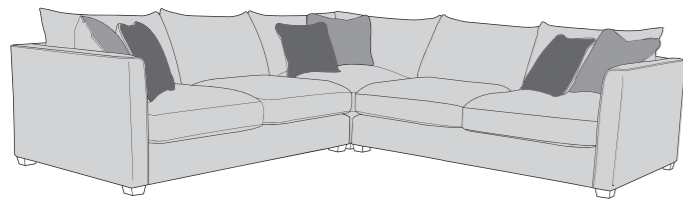

LH2, COR, RH1 Group

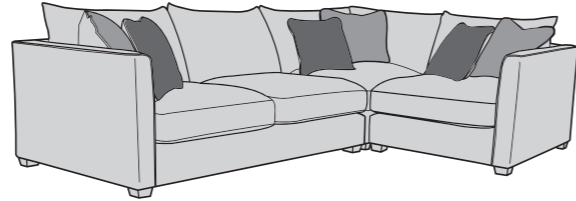

LH1, COR, RH2 Group

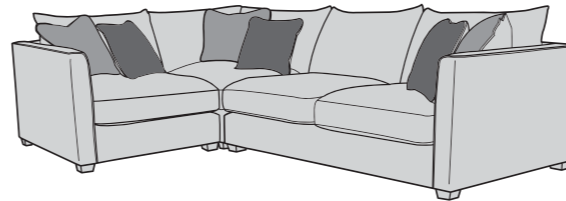

LH1, COR, RH1 Group

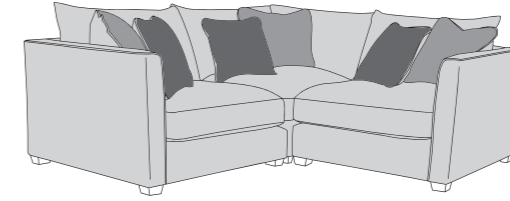

Armless Unit (ALU)

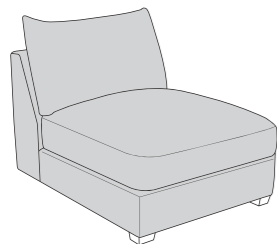

3 Seater Sofa (3ST)

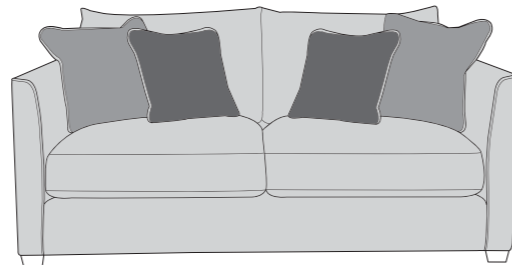

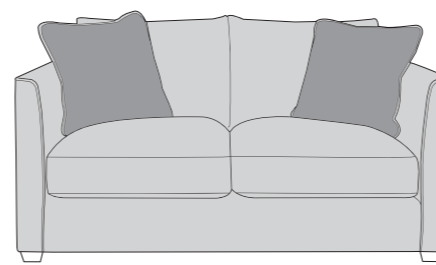

2 Seater Sofa (2ST)

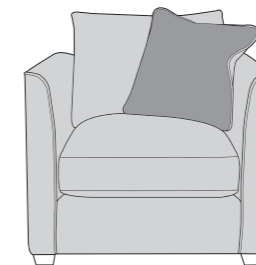

Arm Chair (1ST)



-  **COVER 1**
(BODY)
-  **COVER 2**
(LARGE SCATTER)
-  **COVER 3**
(SMALL SCATTER)

Large Scatter Cushions

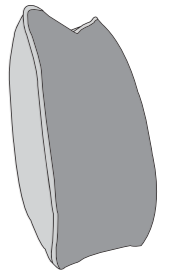

Front = Cover 2
Piping = Cover 1
Reverse = Cover 1

Small Scatter Cushions

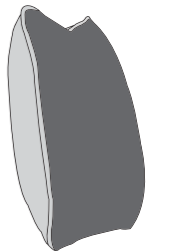

Front = Cover 3
Piping = Cover 1
Reverse = Cover 1

SUGGESTED ACCENT PIECES

Salute Swivel Chair (SWC)

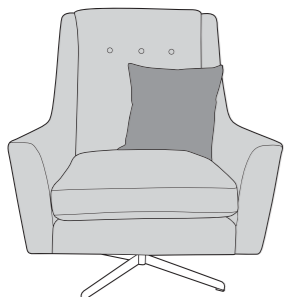

Storage Footstool (FSS)

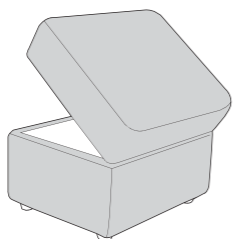

CARTER DIMENSIONS (CM)

AVAILABLE PIECES	HEIGHT 1	WIDTH 2	DEPTH 3	SEAT HEIGHT 4	SEAT DEPTH (STD) 5	SEAT WIDTH 6	ACCESS DIAGONAL 7	OUTBACK HEIGHT 8	ARM HEIGHT 9	WEIGHT (KG)	SCATTER CUSHION NO.
LH2, FST, COR, ALU, RH1 GROUP or LH1, ALU, COR, FST, RH2 GROUP	86	347	267	47	66	N/A	N/A	67	67	167	3 Large, 3 Small
LH2, COR, ALU, RH1 GROUP or LH1, ALU, COR, RH2 GROUP	86	269	267	47	66	N/A	N/A	67	67	149	3 Large, 3 Small
LH2, COR, ALU, FST GROUP or FST, ALU, COR, RH2 GROUP	86	269	258	47	66	N/A	N/A	67	67	131	2 Large, 2 Small
LH2, COR, RH2 GROUP	86	269	269	47	66	N/A	N/A	67	67	140	3 Large, 3 Small
LH2, COR, RH1 GROUP or LH1, COR, RH2 GROUP	86	269	192	47	66	N/A	N/A	67	67	124	3 Large, 3 Small
LH1, COR, RH1 GROUP	86	192	192	47	66	N/A	N/A	67	67	108	3 Large, 3 Small
LH2/RH2 UNIT	86	164	105	47	66	155	194	67	67	52	1 Large, 1 Small
LH1/RH1 UNIT	86	87	105	47	66	78	136	67	67	36	1 Large, 1 Small
COR: CORNER UNIT	86	105	105	47	66	66	144	67	N/A	36	1 Large, 1 Small
ALU: ARMLESS UNIT	86	75	105	47	66	75	129	67	N/A	25	N/A
LARGE FOOTSTOOL (FST)	47	78	105	N/A	N/A	N/A	128	N/A	N/A	18	N/A
3 SEATER SOFA (3ST)											
2 SEATER SOFA (2ST)											
ARM CHAIR (1ST)											
ACCENT PIECES											
SALUTE SWIVEL CHAIR (SWC)	100	90	98	58	60	55	121	N/A	N/A	25.5	1
STORAGE FOOTSTOOL (FSS)	45	63	50	N/A	N/A	N/A	75	N/A	N/A	12.5	N/A

Each unit is fully upholstered, with hidden crocodile clips making them suitable for individual use.

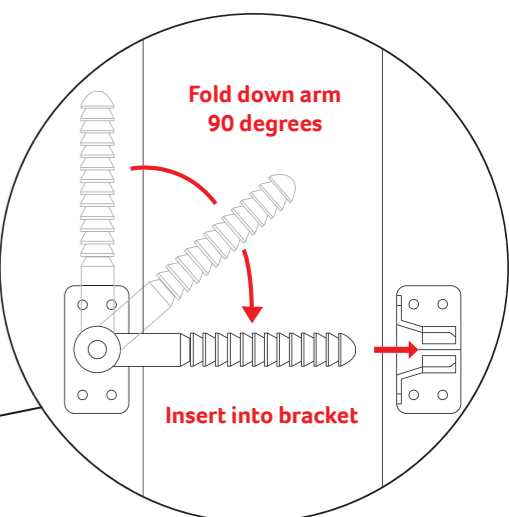

- * Hardwood & composite board frame.
- * Dowelled, screwed, glued & stapled joinery.
- * Light and Dark Wood foot options.

- * Reversible fibre filled backs for added comfort.
- * Feather filled scatter cushions included. 
- * Optional extra fibre bolster available.
- * foamflex+ seat interior.

- * Serpentine seat springs & silent wire.
- * Elasticated back webbing.

DIMENSION GUIDE

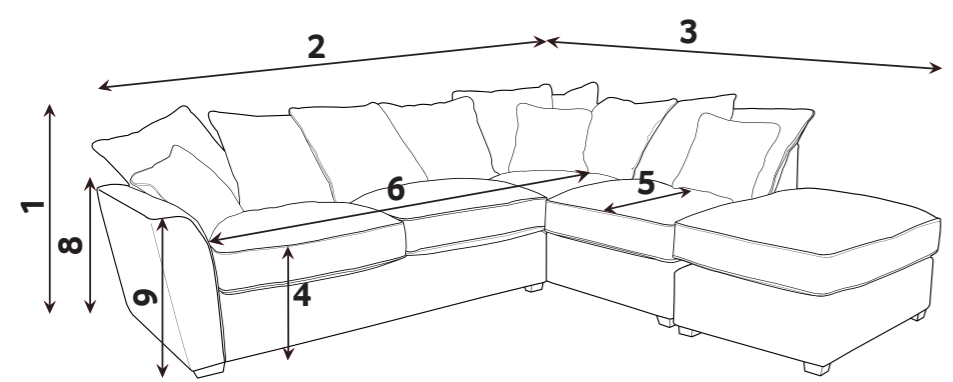

Check the diagonal access dimension to ensure furniture will fit in your home.

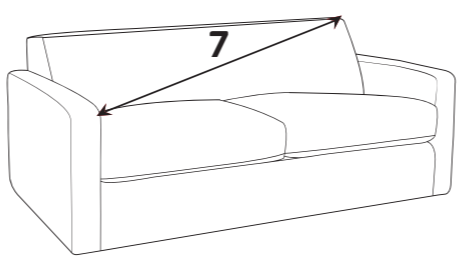

- 1 - HEIGHT
- 2 - WIDTH
- 3 - DEPTH
- 4 - SEAT HEIGHT
- 5 - SEAT DEPTH (STD & PILLOW)
- 6 - SEAT WIDTH
- 7 - DIAGONAL ACCESS
- 8 - OUTBACK HEIGHT
- 9 - ARM HEIGHT

Illustrations used for reference only.

Please note: All dimensions are approximate. Allow tolerance of +/- 2.5cm.

foamflex+

Our expertly engineered foam seat interior gives you the comfort of fibre with the retention of foam.

CARE GUIDE

To improve the longevity of your hand-made furniture, we recommend rotating cushions (where applicable).

For further information on maintaining your furniture, please refer to the Care Guide located under the seat platform.



Beech (light)



Brown (dark)



FOOT OPTIONS:

Wood is a natural product and will vary in shade/colour from item to item. Feet may require fitting.

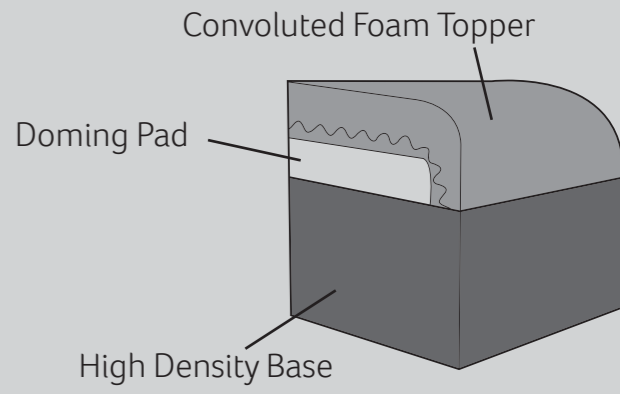

See terms & conditions